

# SPINAL RONGEURS AND PUNCHES



## SECTION 0



To grasp or excise tissue, degenerated disc material or bone during neurological and spinal surgical procedures.

### CONTENTS

Identification Chart	1
Handle Styles	2-3
Intervertebral Disc Rongeurs	4-11
Kerrison Punches	12-18
Laminectomy Punches	14-17
Cervical Punches	15
Foramenotomy Punches	16
Endoscopic Punch	18
Swing Apart Ronguers	19
Clean Wave Kerrisons	20

**IDENTIFICATION CHART**

**SHAFT LENGTH**

Measured in closed position

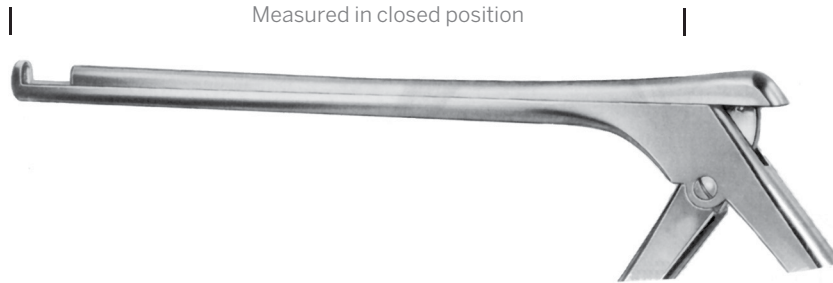

**BITE STYLES**

Punch jaws, thin footplate

Forward 40°

Up 90°

Down 90°

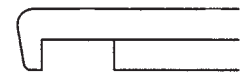
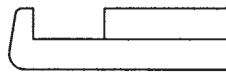

**BITE STYLES**

Punch jaws, regular footplate

Forward 40°

Up 90°

Down 90°

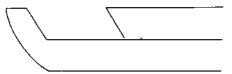

**BITE STYLES**

Cup jaws

Straight

Up

Down

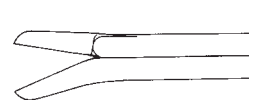

**BITE STYLES**

Footplate

Bite opening

Bite size



Note: All OrthoMed spinal rongeurs and punches have "bite size" etched on handles for easy identification.

**HANDLE STYLES**



Style I  
Ring handle  
Handle height: 4" (102mm)



Style II  
Kerrison handle  
Handle height: 6 1/4" (159mm)



Style III  
Love-Kerrison handle  
(Cherry)  
Handle height: 6" (152mm)



Style IV  
Large Kerrison handle  
Handle height: 6 1/4" (159mm)

---

Note: All OrthoMed spinal rongeurs and punches have "bite size" etched on handles for easy identification.

HANDLE STYLES



Style V  
Small Kerrison Handle  
Handle height: 5"



Style VI  
Ferris-Smith  
Kerrison Ring Handle  
Handle height: 5"



Style VII  
Spurling Kerrison Handle  
Wider grip improves comfort and control.  
Handle height: 4 3/4"



Style VIII  
Medium Kerrison Handle  
Handle height: 5 1/4"

Note: All OrthoMed spinal rongeurs and punches have "bite size" etched on handles for easy identification.

**INTERVERTEBRAL DISC RONGEUR  
(HANDLE STYLE I)**



Straight

Up angle 45°

Down angle 45°

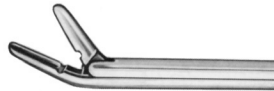

Cushing  
1.5x10mm  
bite straight

OM 47-0740

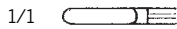

Cushing  
2x10 mm  
bite straight

OM 47-0710 5"  
OM 47-0730 7"  
OM 47-0741 9"



Love-Gruenwald  
3x10 mm  
bite straight

OM 47-0760 5"  
OM 47-0780 7"



Spurling  
4x10 mm  
bite straight

OM 47-0800 5"  
OM 47-0840 7"



Cushing  
2x10 mm  
bite up angle 45°

OM 47-0712 5"  
OM 47-0732 7"  
OM 47-0742 9"



Love-Gruenwald  
3x10 mm  
bite up angle 45°

OM 47-0762 5"  
OM 47-0782 7"



Spurling  
4x10 mm  
bite up angle 45°

OM 47-0802 5"  
OM 47-0842 7"



Cushing  
2x10 mm  
bite down angle 45°

OM 47-0714 5"  
OM 47-0734 7"  
OM 47-0744 9"



Love-Gruenwald  
3x10 mm  
bite down angle 45°

OM 47-0764 5"  
OM 47-0784 7"



Spurling  
4x10 mm  
bite down angle 45°

OM 47-0804 5"  
OM 47-0844 7"

**CASPAR STYLE  
INTERVERTEBRAL DISC RONGEUR  
(HANDLE STYLE I)**



Straight



- 6" straight  
OM 55-0946 2X10mm  
OM 55-0947 3X10 mm  
OM 55-0948 4X10mm  
OM 55-0949 5X10mm

Up angle 45°

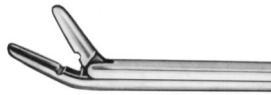

- 6" up angle 45°  
OM 55-0952 2X10mm  
OM 55-0953 3X10 mm  
OM 55-0954 4X10mm

Down angle 45°



- 6" down angle 45°  
OM 55-0940 2X10mm  
OM 55-0941 3X10 mm  
OM 55-0942 4X10mm



- 6 1/4" straight  
Fenestrated jaw, serrated cup  
OM 55-0935 2X12mm  
OM 55-0936 3X12mm  
OM 55-0937 4X14mm  
OM 55-0938 5X14mm



- 7 1/4" up angle 45°  
Fenestrated jaw, serrated cup  
OM 55-0972 3X12mm  
OM 55-0973 4X14mm  
OM 55-0974 5X14mm



- 7 1/4" down angle 45°  
Fenestrated jaw, serrated cup  
OM 55-0966 3X12mm  
OM 55-0967 4X14mm



- 7 1/4" Straight  
Fenestrated jaw, serrated cup  
OM 55-0960 2X12mm  
OM 55-0961 3X12mm  
OM 55-0962 4X14mm  
OM 55-0963 5X14mm  
OM 55-0964 6X14mm

**FERRIS-SMITH INTERVERTEBRAL DISC RONGEUR  
(HANDLE STYLE VI)**

7" (178mm) shaft



Ring handle lessens chance of slippage.

Straight





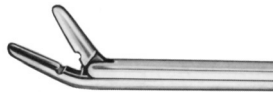

Up angle 45°



Down angle 45°





7" straight

-   
OM 47-0858 2X10mm
-   
OM 47-0864 3X10 mm
-   
OM 47-0870 4X10
-   
OM 47-0878 6X12mm

7" bite up

-   
OM 47-0860 2X10mm
-   
OM 47-0866 3X10 mm
-   
OM 47-0872 4X10mm
-   
OM 47-0873 6X12mm

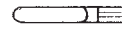
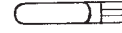
7" bite down

-   
OM 47-0862 2X10mm
-   
OM 47-0868 3X10 mm
-   
OM 47-0874 4X10mm
-   
OM 47-0875 6X12mm

1/1 

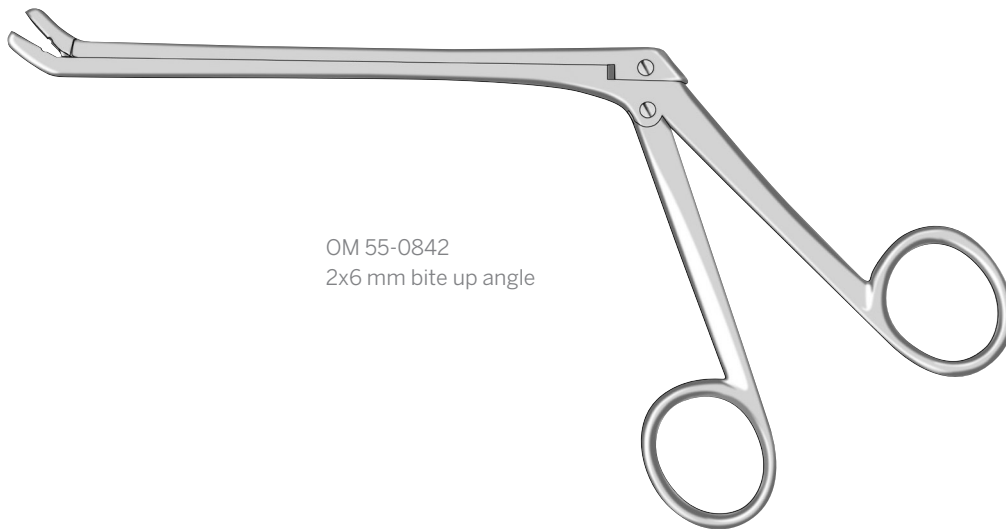

OM 55-0842  
2x6 mm bite up angle

**PEAPOD INTERVERTEBRAL DISC RONGEUR  
(HANDLE STYLE I)**

5 1/2" (140mm) shaft

---

1/1 



OM 55-0800  
3x10 mm bite straight

**TAKAHASHI INTERVERTEBRAL DISC RONGEUR  
(HANDLE STYLE I)**

5 1/2" (140mm) shaft

---



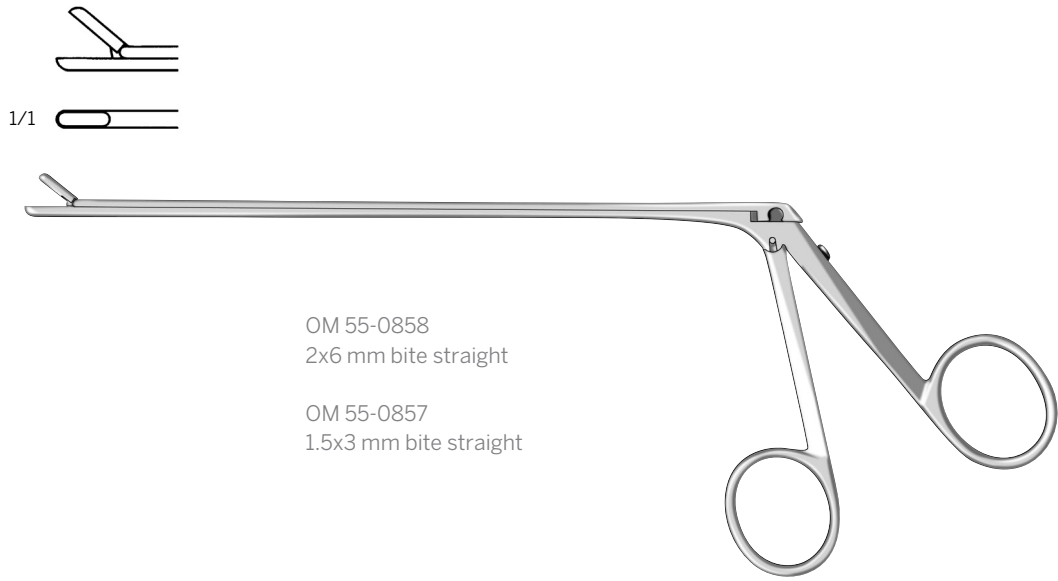

OM 55-0858  
2x6 mm bite straight

OM 55-0857  
1.5x3 mm bite straight

**DECKER INTERVERTEBRAL DISC RONGEUR  
(HANDLE STYLE I)**

6" (152mm) shaft

---



1/1   
OM 47-0707  
small  
4x9 mm bite

1/1   
OM 47-0708  
medium  
5x10 mm bite

1/1   
OM 47-0709  
large  
6x11 mm bite

**WILDE INTERVERTEBRAL DISC RONGEUR (HANDLE STYLE I)**

5" (127mm) shaft  
fenestrated jaws straight

---

1/1 



OM 55-0856  
6 mm bite round

**OLDBERG INTERVERTEBRAL DISC RONGEUR  
(HANDLE STYLE I)**

7" (178mm) shaft

---

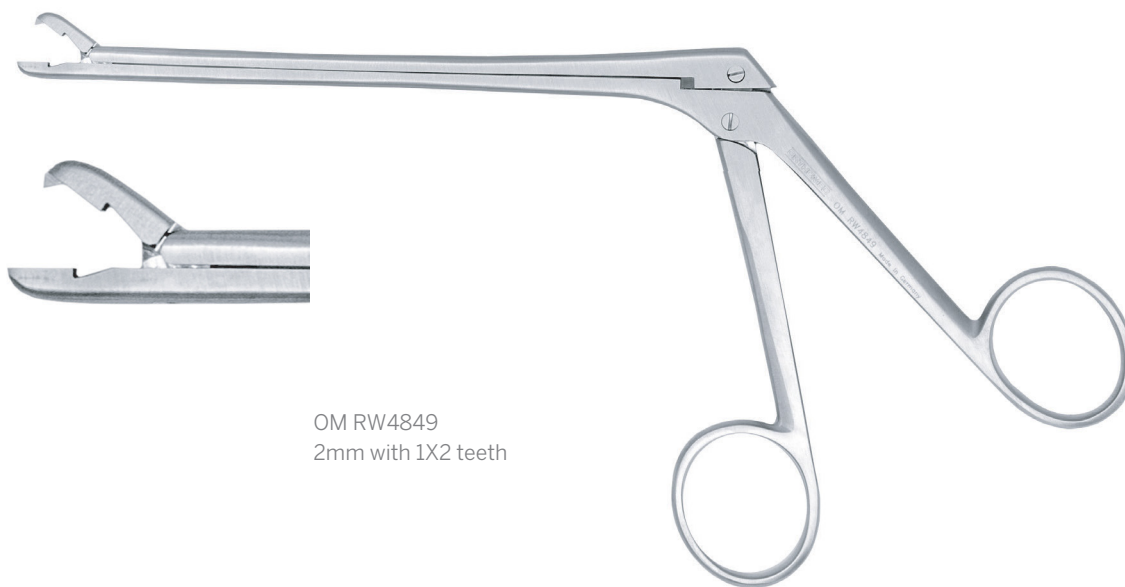

OM RW4849  
2mm with 1X2 teeth

**WILLIAMS IVD RONGEUR**

5 1/4" (135mm)

---

SPINAL IVD RONGEURS

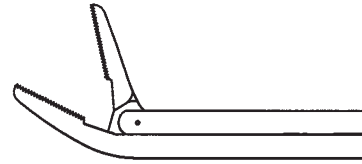
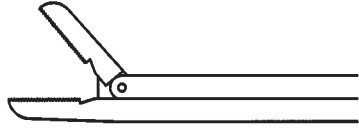

OM 47-0700  
2x10 mm bite  
straight

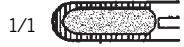

OM 47-0702  
3x10 mm bite  
straight



OM 47-0704  
4x10 mm bite  
straight



OM 47-0703  
3x10 mm bite  
up angle



**SCHLESINGER INTERVERTEBRAL DISC RONGEUR (HANDLE STYLE I)**

6" (152mm) shaft  
serrated jaws

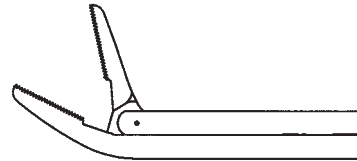
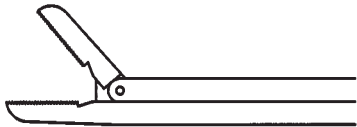

OM 55-0690  
3x10 mm bite  
straight



OM 55-0691  
5x10 mm bite  
straight



OM 55-0693  
3x10 mm bite  
up angle



OM 55-0694  
5x10 mm bite  
up angle



**SCHLESINGER INTERVERTEBRAL DISC RONGEUR (HANDLE STYLE I)**

9" (229mm) shaft  
serrated jaws

1/1 

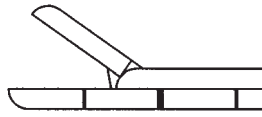

OM 55-0762  
2 1/2x10 mm  
bite straight

1/1 

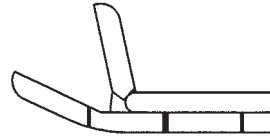

OM 55-0767  
4x10 mm  
bite up angle

1/1 

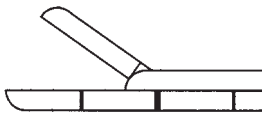

OM 55-0763  
4x10 mm  
bite straight

1/1 

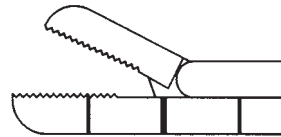

OM 55-0777  
8x12 mm  
bite straight, serrated

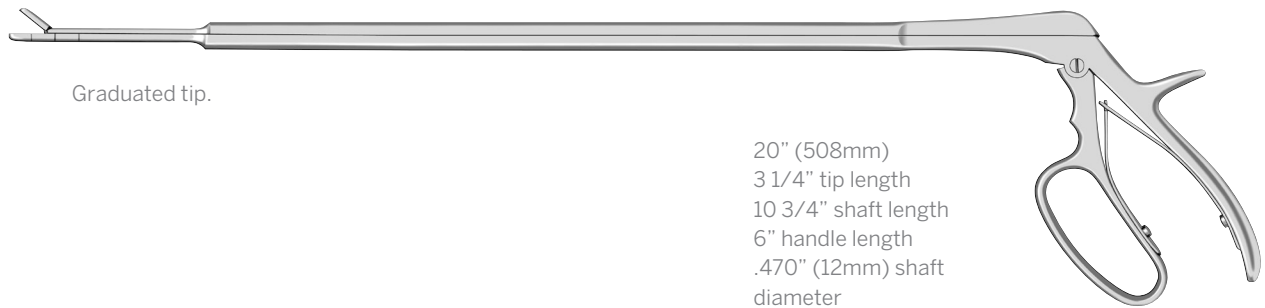

Graduated tip.

20" (508mm)  
3 1/4" tip length  
10 3/4" shaft length  
6" handle length  
.470" (12mm) shaft  
diameter

**FERRIS-SMITH INTERVERTEBRAL DISC RONGEUR ENDOSCOPIC  
(HANDLE STYLE VI)**

# SPINAL PUNCHES



**Note:**

- Thin footplate designed specifically for small bone in the cervical area
- Gold hexagonal screw denotes thin footplate
- "Bite size" etched on handle for quick identification
- Care should be taken when using delicate thin footplate punches
- Do not twist or pry instrument while cutting
- Do not use on large bones



Forward 40° Thin Footplate

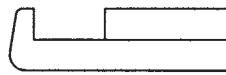

Up 90° Thin Footplate

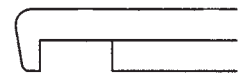

Down 90° Thin Footplate

1/1 □ 1mm bite forward  
 OM 55-0891 6" (152mm)  
 OM 55-0904 7" (178mm)  
 OM 55-0925 8" (203mm)

1/1 □ 1mm bite up  
 OM 55-0905 7" (178mm)

1/1 □ 1mm bite down  
 OM 55-0906 7" (178mm)

1/1 □ 2mm bite forward  
 OM 55-0892 6" (152mm)  
 OM 55-0908 7" (178mm)  
 OM 55-0926 8" (203mm)

1/1 □ 2mm bite up  
 OM 55-0909 7" (178mm)

1/1 □ 2mm bite down  
 OM 55-0910 7" (178mm)

1/1 □ 3mm bite forward  
 OM 55-0895 6" (152mm)  
 OM 55-0911 7" (178mm)  
 OM 55-0927 8" (203mm)

1/1 □ 3mm bite up  
 OM 55-0912 7" (178mm)

1/1 □ 3mm bite down  
 OM 55-0913 7" (178mm)

1/1 □ 4mm bite forward  
 OM 55-0898 6" (152mm)  
 OM 55-0914 7" (178mm)  
 OM 55-0928 8" (203mm)

1/1 □ 4mm bite up  
 OM 55-0915 7" (178mm)

1/1 □ 4mm bite down  
 OM 55-0916 7" (178mm)

1/1 □ 5mm bite forward  
 OM 55-0901 6" (152mm)  
 OM 55-0917 7" (178mm)  
 OM 55-0929 8" (203mm)

1/1 □ 5mm bite up  
 OM 55-0918 7" (178mm)

1/1 □ 5mm bite down  
 OM 55-0919 7" (178mm)

1/1 □ 6mm bite forward  
 OM 55-0930 8" (203mm)

## THIN FOOTPLATE KERRISON PUNCH (HANDLE STYLE V)



**Note:**

- Thin footplate designed specifically for small bone in the cervical area
- Gold hexagonal screw denotes thin footplate
- "Bite size" etched on handle for quick identification
- Care should be taken when using delicate thin footplate punches
- Do not twist or pry instrument while cutting
- Do not use on large bones

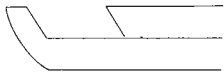

Forward 40° Regular Footplate





Up 90° Regular Footplate





Down 90° Regular Footplate

1/1  **1mm bite forward**  
OM 47-0879 7" (178mm)  
OM 48-0015 8" (203mm)

1/1  **2mm bite forward**  
OM 47-0996 7" (178mm)  
OM 48-0024 8" (203mm)  
OM 47-0685 11" (279mm)

1/1  **3mm bite forward**  
OM 47-0997 7" (178mm)  
OM 48-0025 8" (203mm)  
OM 47-0686 11" (279mm)

1/1  **4mm bite forward**  
OM 47-0998 7" (178mm)  
OM 48-0026 8" (203mm)  
OM 47-0687 11" (279mm)

1/1  **5mm bite forward**  
OM 47-0999 7" (178mm)  
OM 48-0027 8" (203mm)  
OM 47-0688 11" (279mm)

1/1  **6mm bite forward**  
OM 47-0855 7" (178mm)  
OM 48-0028 8" (203mm)  
OM 48-0029 11" (279mm)

1/1  **2mm bite up**  
OM 47-0988 7" (178mm)  
OM 48-0016 8" (203mm)

1/1  **3mm bite up**  
OM 47-0989 7" (178mm)  
OM 48-0017 8" (203mm)

1/1  **4mm bite up**  
OM 47-0990 7" (178mm)  
OM 48-0018 8" (203mm)

1/1  **5mm bite up**  
OM 47-0991 7" (178mm)  
OM 48-0019 8" (203mm)

1/1  **6mm bite up**  
OM 47-0857 7" (178mm)

1/1  **2mm bite down**  
OM 47-0992 7" (178mm)  
OM 48-0020 8" (203mm)

1/1  **3mm bite down**  
OM 47-0993 7" (178mm)  
OM 48-0021 8" (203mm)

1/1  **4mm bite down**  
OM 47-0994 7" (178mm)  
OM 48-0022 8" (203mm)

1/1  **5mm bite down**  
OM 47-0995 7" (178mm)  
OM 48-0023 8" (203mm)

1/1  **6mm bite down**  
OM 47-0856 7" (178mm)

**SPURLING KERRISON PUNCH  
(HANDLE STYLE V)**

# SPINAL PUNCHES

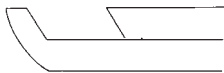

forward 40° Regular Footplate





Up 90° Regular Footplate





Down 90° Regular Footplate

1/1  2mm bite forward  
OM 47-0676 8" (203mm)

1/1  3mm bite forward  
OM 47-0670 6" (152mm)  
OM 47-0678 8" (203mm)

1/1  4mm bite forward  
OM 47-0680 8" (203mm)

1/1  5mm bite forward  
OM 47-0674 6" (152mm)  
OM 47-0682 8" (203mm)

1/1  6mm bite forward  
OM 47-0689 11" (279mm)

1/1  3mm bite up  
OM 47-0644 6" (152mm)  
OM 47-0652 8" (203mm)

1/1  4mm bite up  
OM 47-0645 6" (152mm)  
OM 47-0853 8" (203mm)

1/1  5mm bite up  
OM 47-0646 6" (152mm)  
OM 47-0654 8" (203mm)

1/1  3mm bite down  
OM 47-0648 6" (152mm)  
OM 47-0656 8" (203mm)

1/1  4mm bite down  
OM 47-0649 6" (152mm)  
OM 47-0657 8" (203mm)

1/1  5mm bite down  
OM 47-0650 6" (152mm)  
OM 47-0658 8" (203mm)

## LOVE-KERRISON LAMINECTOMY PUNCH (HANDLE STYLE IV) LARGE HANDLE



up bite regular footplate

1/1  3mm bite up  
OM 47-0610

1/1  5mm bite up  
OM 47-0612



down bite regular footplate

1/1  3mm bite down  
OM 47-0614

1/1  5mm bite down  
OM 47-0616



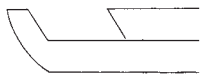

**SCHLESINGER CERVICAL LAMINECTOMY PUNCH (HANDLE STYLE IV) LARGE HANDLE**

6" (152mm) shaft  
regular footplate



forward 40° regular footplate

1/1  3mm bite  
OM 55-0813 7"  
OM 55-0823 8"

1/1  5mm bite  
OM 55-0815 7"  
OM 55-0825 8"

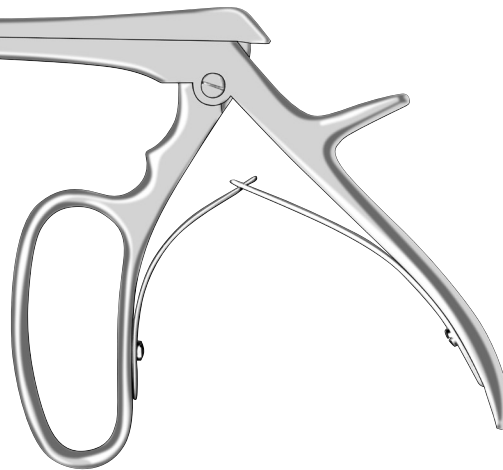

**FERRIS SMITH KERRISON PUNCH (HANDLE STYLE V)**

Regular footplate



# SPINAL PUNCHES

---

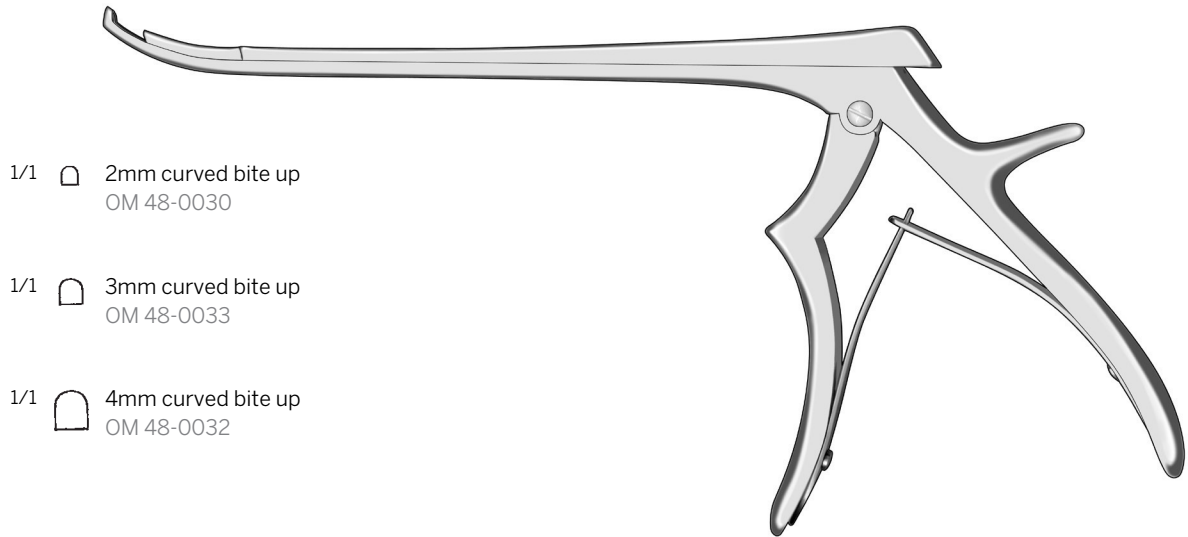

## FORAMENOTOMY PUNCH (HANDLE STYLE V)

8" (203mm) shaft  
regular footplate

---



*Fenestrated upper shaft ejects cut pieces of bone and tissue.*

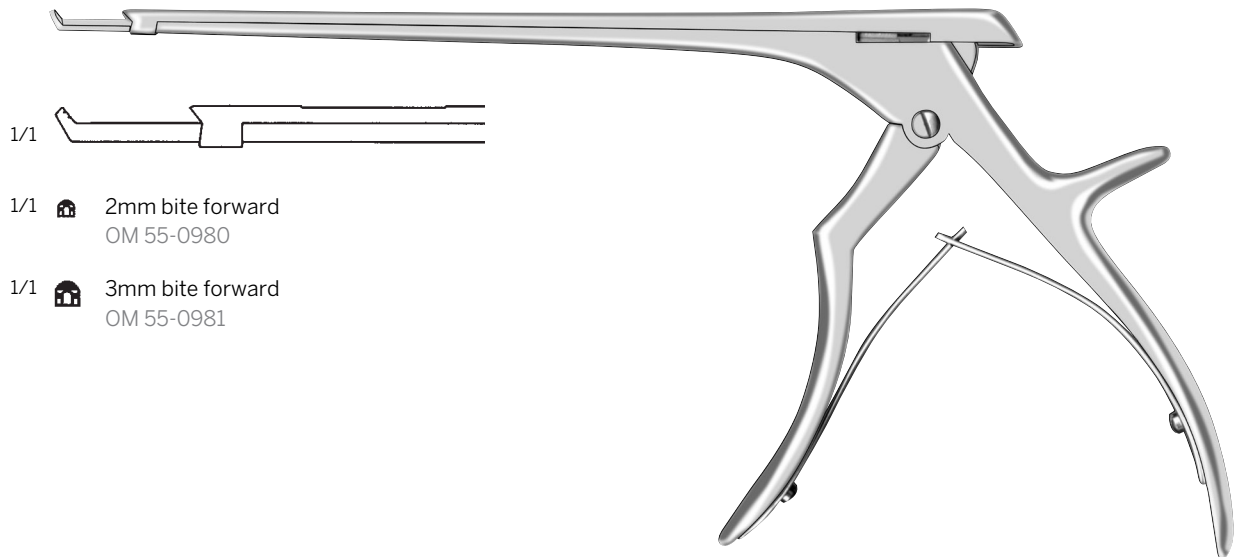



## MULTI-BITE KERRISON PUNCH (HANDLE STYLE VIII)

7" (178mm) shaft  
delicate thin footplate. For cervical use only.

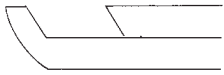
---



forward 40° regular footplate

- 1/1  2mm bite  
OM 47-0685
- 1/1  3mm bite  
OM 47-0686
- 1/1  4mm bite  
OM 47-0687
- 1/1  5mm bite  
OM 47-0688
- 1/1  6mm bite  
OM 48-0029



*Compact handle designed to accommodate smaller hands.*

**SPURLING KERRISON PUNCH (HANDLE STYLE V)**

11" (280mm) shaft  
regular footplate

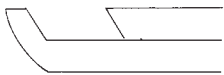

forward 40° regular footplate

- 1/1 



OM 47-0689  
11" (280mm) shaft  
6mm bite forward  
regular footplate

**LOVE-KERRISON LAMINECTOMY PUNCH (HANDLE STYLE IV) LARGE HANDLE**

Regular footplate

# SPINAL PUNCHES

---

1/1 



OM 55-0788  
2.5mm bite forward  
forward 40°

1/1 

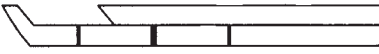

OM 55-0790  
4mm bite forward  
forward 40°

1/1 



OM 55-0782  
4mm bite down  
down 90°



*Graduated tip.*

20" (508mm)  
3 1/4" tip length  
10 3/4" shaft length  
6" handle length  
.470" (12mm) shaft diameter  
regular footplate

## FERRIS-SMITH KERRISON PUNCH ENDOSCOPIC

15mm Jaw opening



Small handle.

40 degree forward with 15mm opening small handle

- OM 59-0111 1mm
- OM 59-0112 2mm
- OM 59-0113 3mm
- OM 59-0114 4mm
- OM 59-0115 5mm
- OM 59-0116 6mm

thin foot plate

- OM 59-0121 1mm
- OM 59-0122 2mm
- OM 59-0123 3mm
- OM 59-0124 4mm
- OM 59-0125 5mm
- OM 59-0126 6mm

## FERRIS SMITH KERRISON RONGEUR



- OM 59-0313 1mm
- OM 59-0315 2mm
- OM 59-0316 3mm
- OM 59-0321 4mm
- OM 59-0322 5mm

matte black ceramic finish

- OM 59-0313E 1mm
- OM 59-0315E 2mm
- OM 59-0316E 3mm
- OM 59-0321E 4mm
- OM 59-0322E 5mm

## SWING APART KERRISON RONGEUR TFP

8" 40 degree forward

## CATCH THE NEW WAVE IN EASY CLEANING.

In most spinal punches, tissue and debris can collect and remain trapped between the main body and slider. This build-up can impede the smooth function of the instrument and prevent proper sterilization as a result of not being completely cleaned prior to sterilization.

The Clean Wave Kerrison Punch has a slider with a wavelike shaped design which allows cleaning brushes easy access through the recesses and openings between the slider and main body for cleaning prior to sterilization.

- Wavelike shape also helps to reduce friction between the slider and main body, providing a smooth function.
- Forward angled foot plate provides precise and controlled cutting action.
- Features a thin foot plate design.
- Bone ejector is incorporated into the design of 2mm-5mm bite sizes.
- Made from German stainless steel.
- Satin finish helps to reduce glare.



## CLEAN WAVE KERRISON RONGEUR

8" (203mm)

Ferris-Smith-Kerrison handle, thin foot plate

OM 62-0411	1mm without ejector
OM 62-0412	2mm without ejector
OM 62-0413	3mm without ejector
OM 62-0414	4mm without ejector
OM 62-0415	5mm without ejector

7" (178mm)

Ferris-Smith-Kerrison handle, thin foot plate

OM 62-0221	1mm without ejector
OM 62-0222	2mm without ejector
OM 62-0223	3mm without ejector
OM 62-0224	4mm without ejector
OM 62-0225	5mm without ejector